

Buggy Wrenches

a.k.a. Axle Nut Wrenches

Mike Harrold
Industrial Survey Volunteer
November 2023

Amesbury Carriage Museum
Amesbury, MA

Wagon and Carriage Axles

Nineteenth century wagon and carriage wheels had iron tires that never went flat, so rarely needed changing. Vehicle repairs might have occasionally required removing wheels, but a more frequent need would have been re-lubricating of wheel journals. (At ACM, wheels are sometimes removed in order to fit larger carriages through doors.)

Work wagons were generally heavy-duty wood vehicles having massive wood axles and journals to carry heavy loads. Wood journals were thus large in diameter, for strength, and sheathed in iron or steel skeins (shown below) to resist wear. In contrast, carriages were intentionally light, having iron axles with slender journals. Journals on both had grease grooves for lubrication, but lightly loaded carriage journals could run much longer without lubricating. Work wagons needed more frequent grease packing, and farmers would have serviced their own equipment in their farmyards. (Axle nut wrenches and wagon jacks are collected by farm equipment enthusiasts.) In any event, wrenches were required to remove axle nuts and it would have been desirable that nuts stay clean of sand and grit by keeping them off the ground.

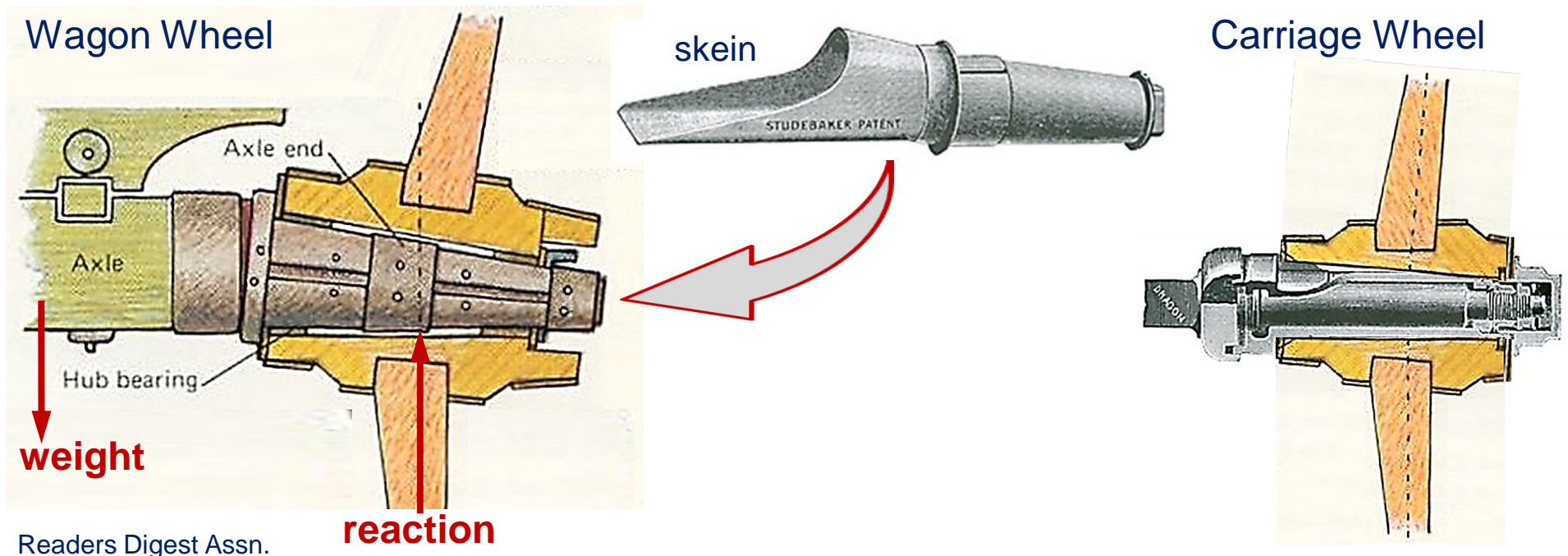

Carriage Axles, Journals, Axle Nuts, and Lubrication

axle and journal-box assembly, Concord Axle Co. of Fisherville, New Hampshire

A number of iron-working companies made matched assemblies of axles and wheel journal boxes, distributed through carriage hardware dealers. In order to resist side loads, wheels had dished spokes and axles had tapered journals having a horizontal bottom surfaces (previous page). Journal boxes were assembled into wheel hubs and their matched assembly to axles provided precision clearances for free turning, plus friction faces to carry both vertical weight and horizontal side loads. Journal boxes and their wheel hubs were retained on axles by axle nuts having flanged friction faces for side loads. As general hardware, most nineteenth century nuts were square.

Axle journals had grooves for oil or oil-saturated packings of leather or felt, and friction faces were likewise lubricated. Final assemblies frequently had additional features to exclude dirt, and wheel hubs had collars that surrounded axle nuts for cleanliness, sometimes closed off with hub caps (see Sheldon Axle assembly on later page).

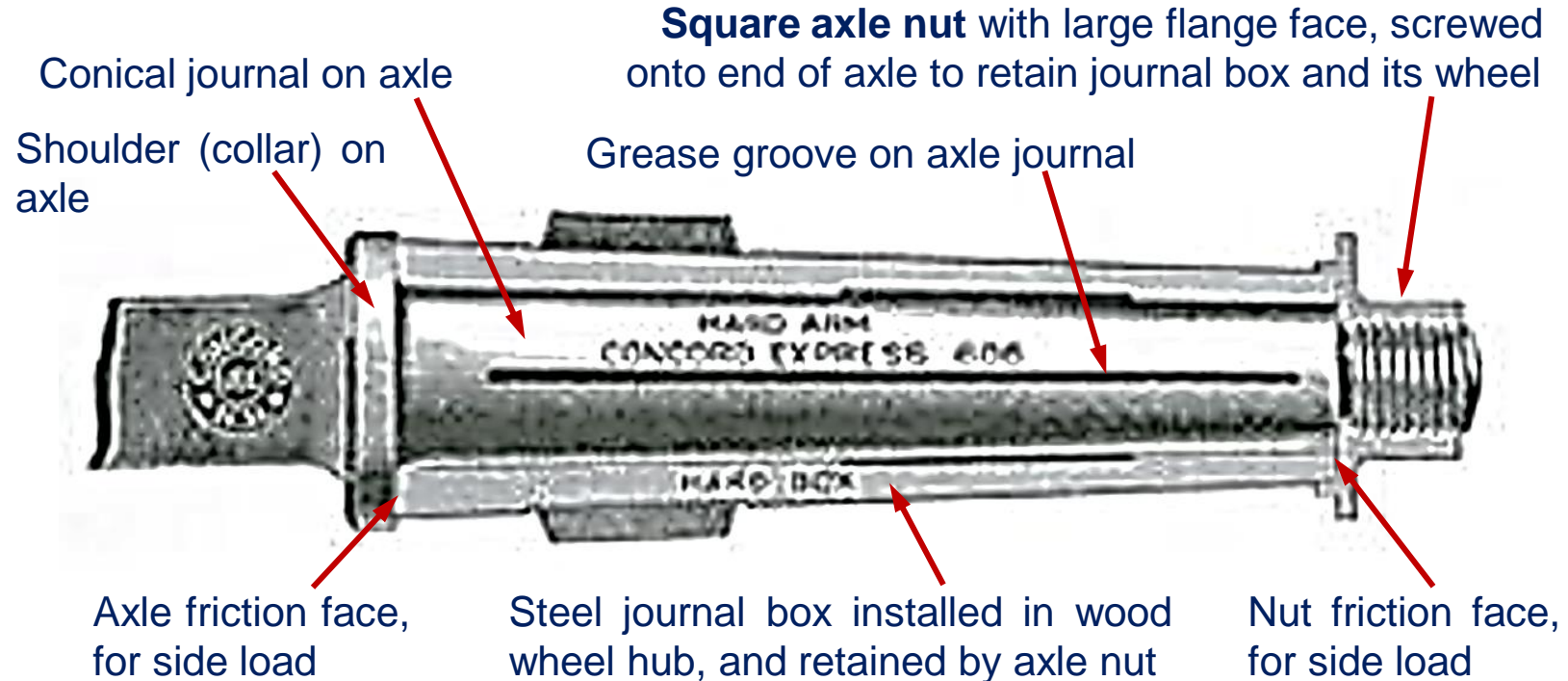

Buggy Wrenches with Open Ends and Offset Box Ends

The surrounding wheel hub imposes that axle nuts can be reached only from one end. Wrench offset box-ends extend inside hubs to access axle nuts, defining buggy wrenches.



Ebay.com



ACM Buggy Wrenches

Axles, Axle Nuts, and Wheel Journal Assemblies

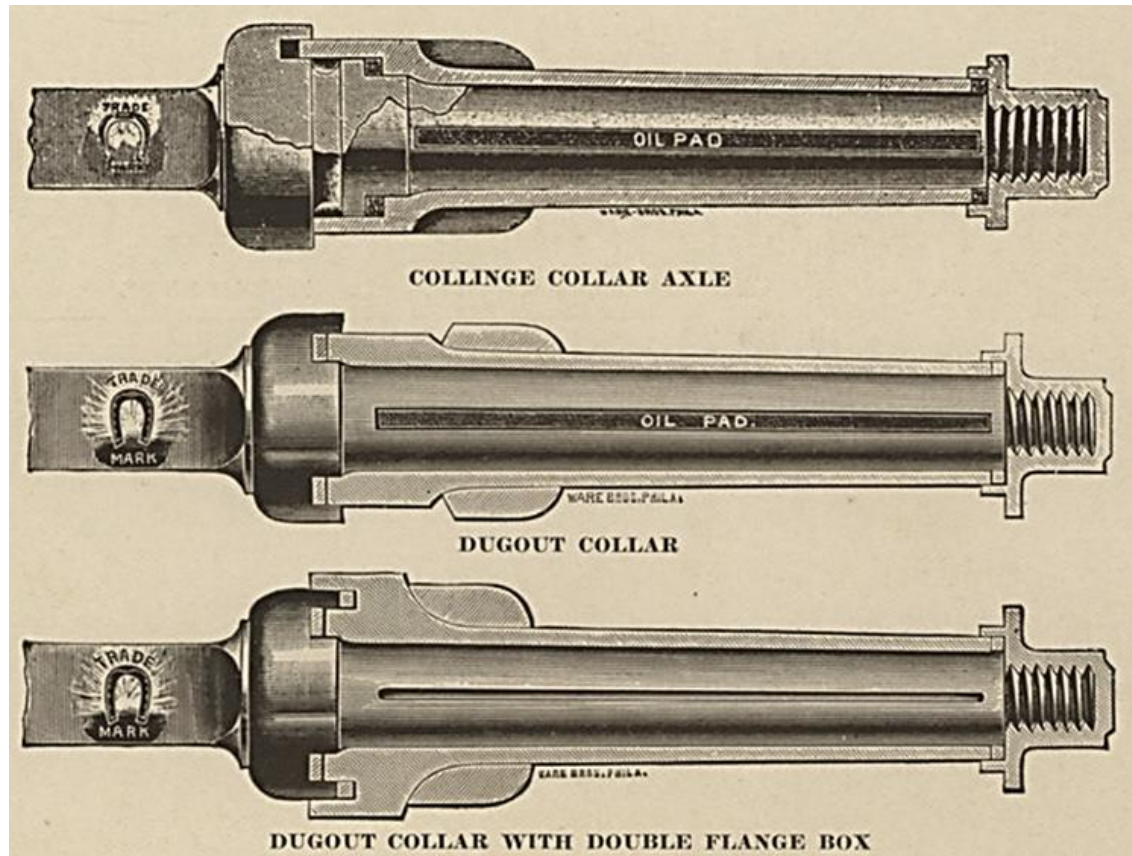

Spears Axle Co. Image on Flickr, Canton, Ohio Public Library

Axle nuts hold together precision-fitted and well-lubricated assemblies of axle and wheel journals designed to exclude dirt that would cause wear. Included can be lubricated felt pads and leather washers in between rotating and stationary metal parts. A washer may rotate unless pressed into the rim of a stationary metal recess, which includes some axle nuts (next page).

An axle nut may mate with a rotating component, causing drag that might gradually rotate the nut. Drag in a forward moving carriage would tend to tighten axle nuts on the carriage right side, but loosen axle nuts on the left side, assuming all right-handed threads (tighten in clockwise direction). To prevent possible nut and wheel loss, axles and nuts on the left side have left-handed threads (tighten in anti-clockwise direction), so that axles must be assembled to carriages accordingly.

Axle Nuts

Some axle nuts are open-ended (the axle protrudes through the nut) but for dirt exclusion many are closed ended. Square heads have a slight taper, in order to release forming dies used during hot-forging of rough nut blanks.

Nuts can include oiled leather washers in the form of rings fitted into circular grooves on nut inner faces, as seen in the smaller nut face directly below.

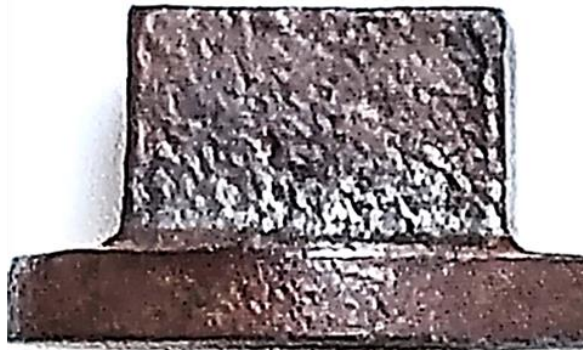

ACM photos

Buggy Wrenches and Carriage Bolts

general vehicle wrenches

The vast majority of buggy wrenches were simple flat wrenches with offset box ends for axle nuts. Because the narrow space inside the wheel hub required a thin-walled wrench, the wrenching feature was formed into a complete closed square to increase its rigidity and strength. As seen on a previous page, wrenches were also intended for general vehicle use, functioning for more than just axle nuts. They thus offered open-ended slots for a group of commonly used square-nut sizes. An additional convenience with carriage work was the use of “carriage bolts”, seen at right. Such bolts have no wrenching feature on their heads, instead having a square section directly underneath the head and above the threads. Carriage bolts were used in the many instances in which a metal part was joined to another part, the latter of either wood or metal.

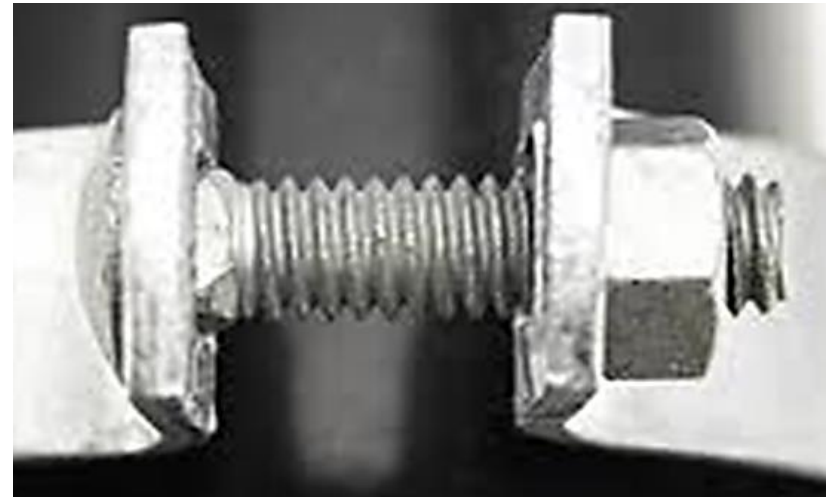

Especially when joining to wood, the strongest and most durable joint was for the thread to pass completely through the wood to mate with a washer and nut on the opposite side. Such a joint would not pull apart. A carriage bolt would mate with a square hole in the metal part, thus being unable to turn at all. An immediate convenience is that no wrench or driver is required for the head end, only for the nut opposite. Carriage bolts are consequently still used for joining latches and strap hinges to fence gates and shed doors, and are ideal where there may be no wrenching access to the bolt head.

Sheldon Axle Co. Assembly with Hex Nut

axle & journal-box assembly, Sheldon Axle Co. of Wilkes-Barre, Pennsylvania

The Sheldon journal assembly has dirt-excluding features with grease packings inside for sealing and lubrication. The wheel journal box has a collar protruding into a slot in the axle collar (red circle below left) to discourage dirt entry. The axle nut is captured by a cotter key, and then the entire end is covered by a threaded hub cap that screws onto the wheel hub journal box.

Sheldon used hex-style axle nuts rather than the nearly universal square nuts of the period, thus offering wrenches having hex shaped offset box ends. The wrench image below was found online; the ACM Sheldon wrench is similar but with a much larger hex for their hub cap.

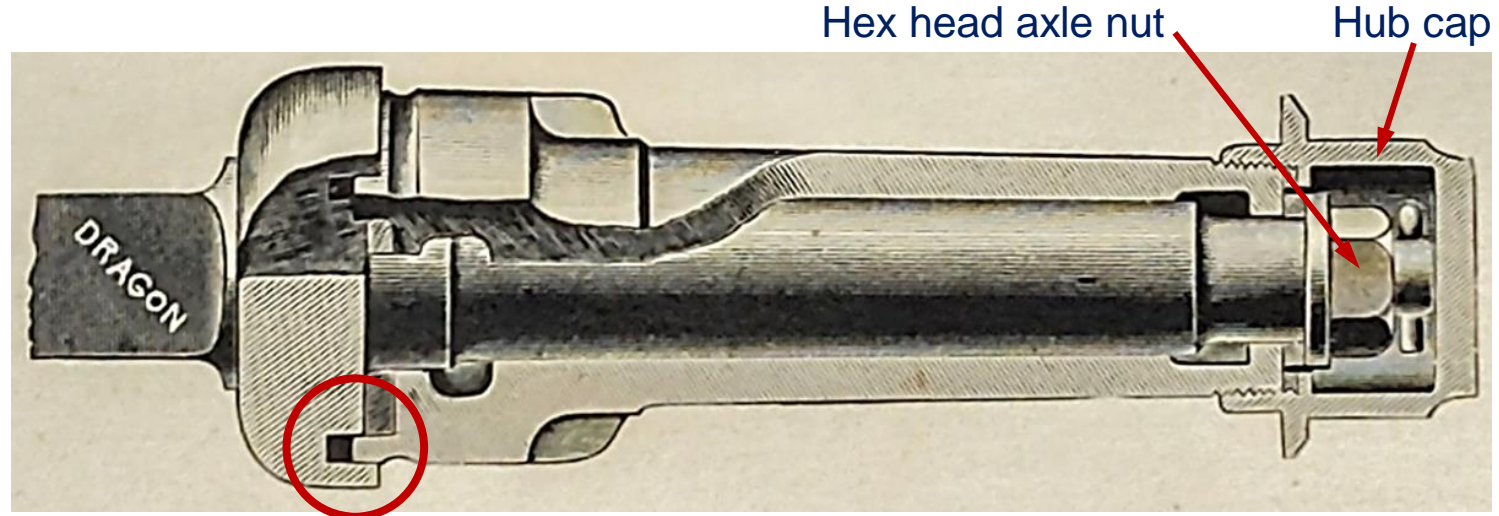

Plain Buggy Wrenches from Henry H. Babcock Co.

ACM wrenches shown here are from Watertown, New York carriage maker H. H. Babcock (spelled out along the handle). This was a mid-to-large-sized and long-lasting company (1845-1926), having no relationship to Frank A. Babcock who at one time was Amesbury's largest carriage manufacturer. (See a portion of the Henry H. Babcock factory, next page.) These wrenches are for two different nut sizes, raising the immediate issue that multiple wrenches are needed for the range of nut sizes. Then, as today, that inconvenience was alleviated by adjustable wrenches, although the owner of a single carriage would need only one wrench size.

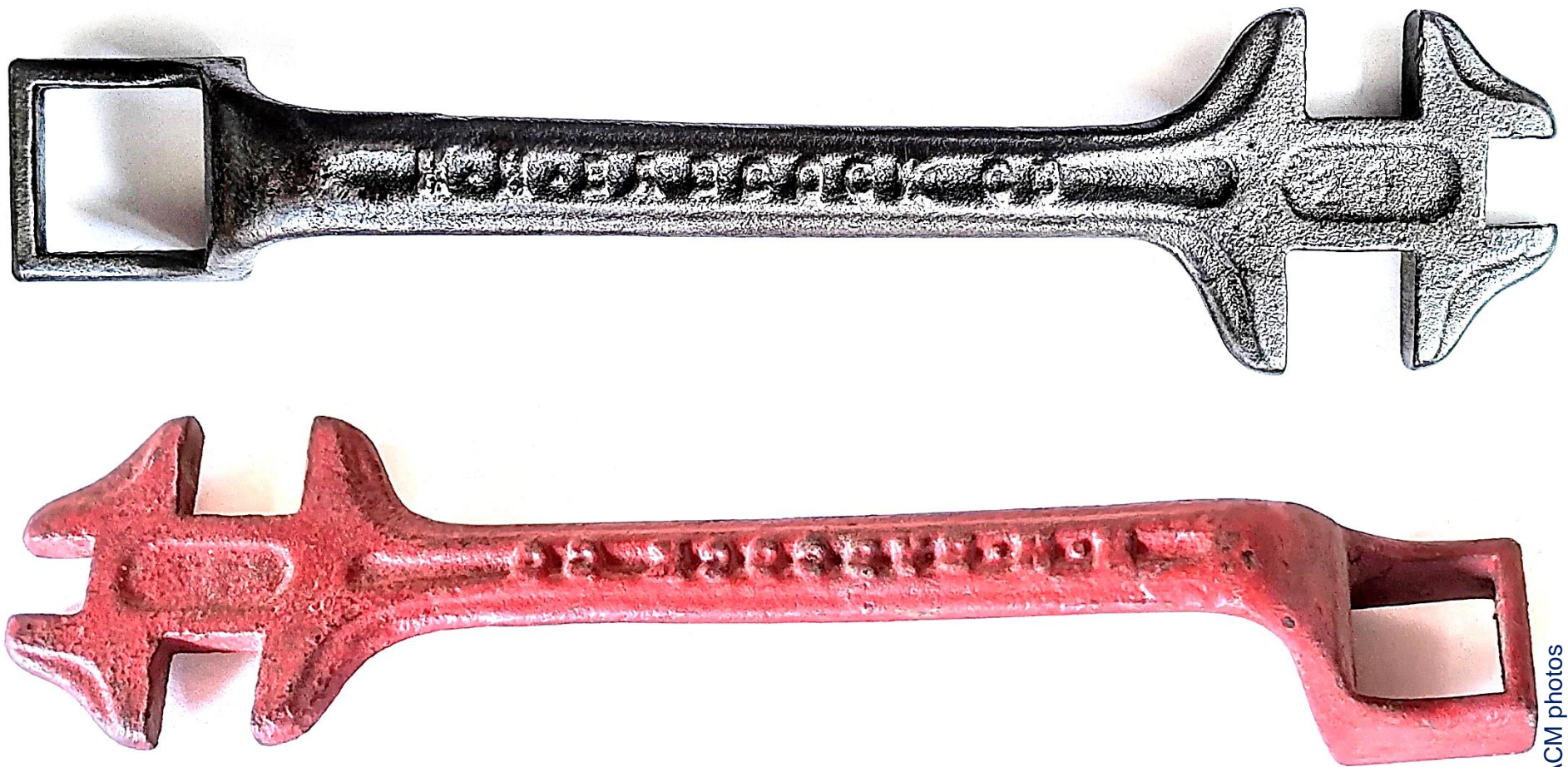

Henry H. Babcock Carriage Co. of Watertown, New York

Below is part of the H. H. Babcock complex; additional buildings extend back behind those shown. The company grew to making a wide range of carriage types, including elaborate park carriages and fully enclosed brougham and Rockaway vehicles, with showrooms in New York and elsewhere. With the automotive era they began making automobile bodies, truck bodies for Ford, and several styles of complete automobiles¹.

1) http://www.virtualsteamcarmuseum.org/makers/babcock_h_h_company.html

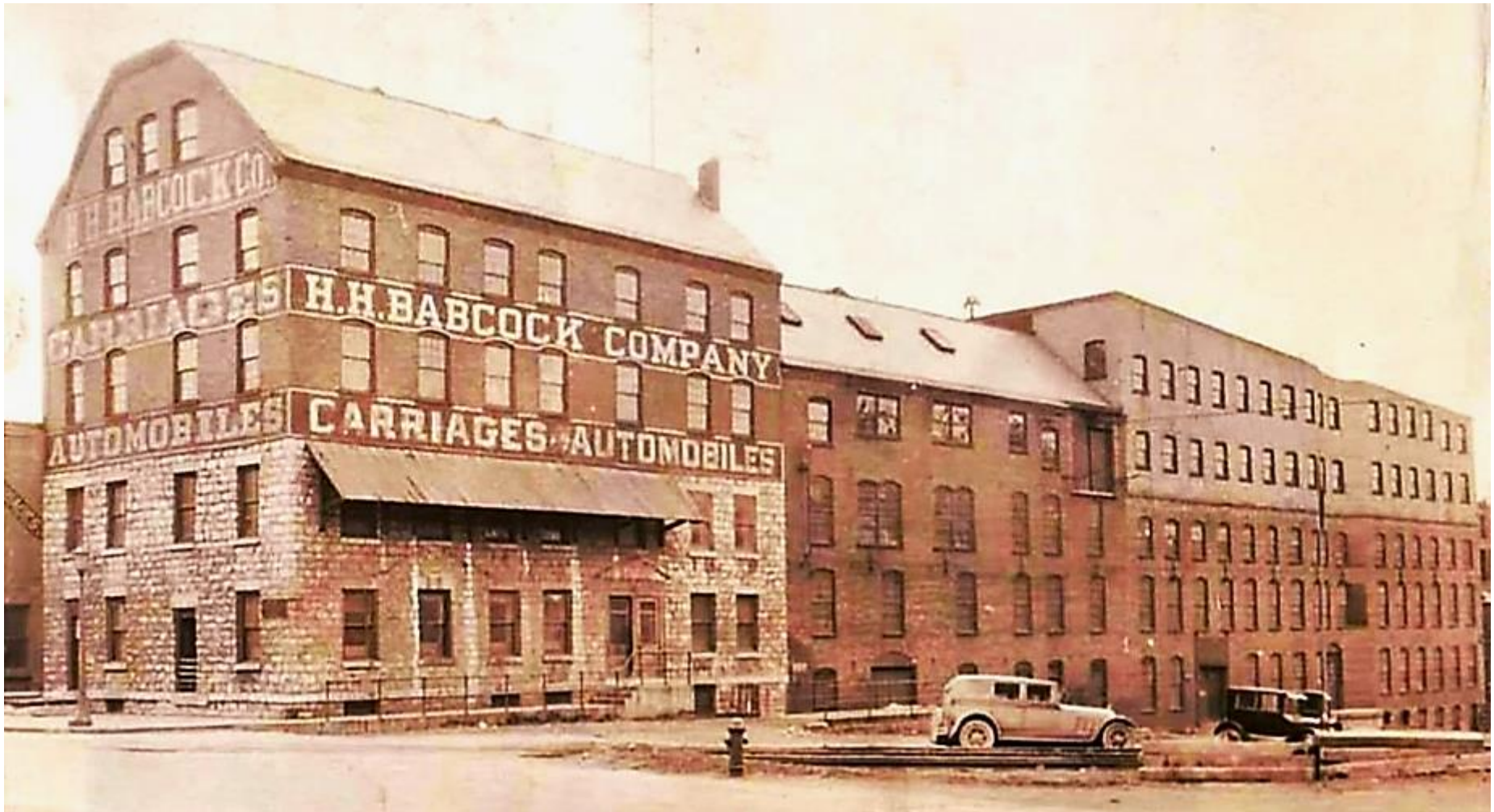

<https://memoryln.net/places/united-states/new-york/watertown/business/h-h-babcock-co-factory-square/>

Roswell F. Cook Nut-Holding Wrench

Patent 325,503, September 1, 1885

With some awkwardness in manipulating the nut and wrench together without dropping the nut, a sometimes-used concept was for the nut to be grasped by the wrench in some manner, which could also help to keep the nut away from dirt after removal. The ACM wrench shown was invented by Roswell Cook of Ilion, New York (home of Remington Arms Company). Squeezing the handle below the wrench releases the nut, the spring atop the wrench otherwise keeping the handle and lever in contact with the nut and retaining it within the wrench. Such a spring-loaded holder does not fully lock in the nut, in which case the nut may slip out if sufficiently forced.

Nut, retained in wrench by spring-loaded lever *H-I*

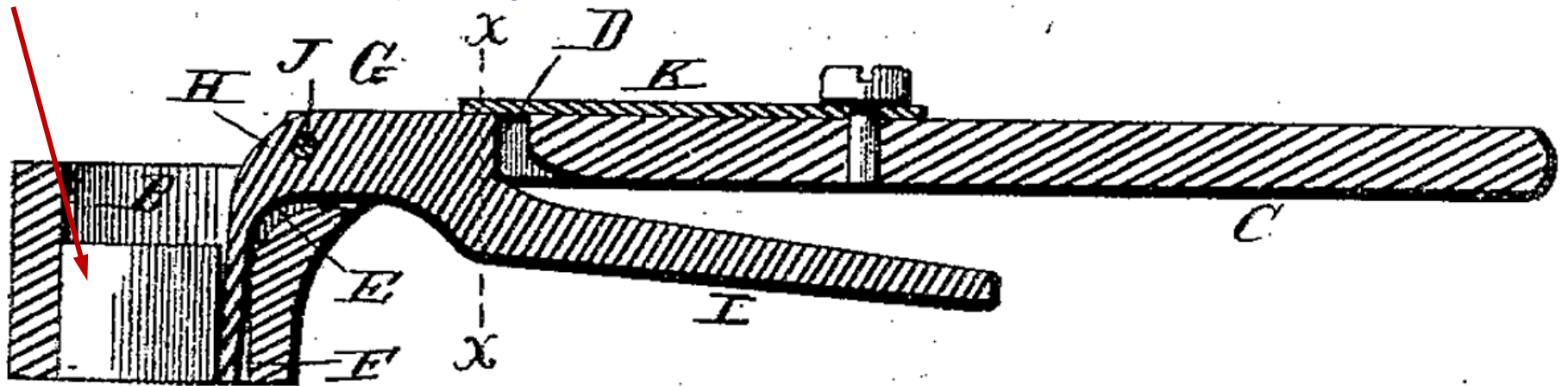

Henry W. Getman Nut-Holding Wrench

Patent 349,581, September 21, 1886

A wrench very much like the previous Roswell Cook example, Getman also working in Ilion, New York. (Perhaps there was a relationship, as if they developed the concept together). The mechanism is essentially a re-arranged form of the Cook design, further raising the question of why a patent was allowed. However, patent law permits “re-arranging the furniture” if the new arrangement is somewhat non-obvious and holds unique advantages.



The highly arched Getman wrench more readily projects the nut forward into the wheel hub, and then the lever can be easily pressed by the thumb to release the nut. It is more convenient to use than is the previously shown Cook design.

A Simple Adjustable Axle Nut Wrench

Shown below is a simple form of adjustable axle nut wrench in which a movable jaw of the wrench may be shifted along a slot in the wrench body. (Not an ACM wrench.) The movable jaw is clamped in place by a wing-nut on the back side. This design provides little ability to firmly lock a nut into the wrench with a tight grip.



Ebay.com

Another Simple Adjustable Axle Nut Wrench

Marked under handle "101 Universal Wrench Co., Bartow, Florida, Pat. 1921". This example is a general utility wrench of the early 20th century, built for hex-style nuts, that is able to reach into a wheel hub and lock onto an axle nut. It is an interesting wrench, in any event. No information has been found regarding the company or their patents.



ACM Photos

Adjustable Wrenches Designed for Axle Nut Use

Henry Artemus Thompson (Farmington, ME) patent 234,091 of November 2, 1890

Below are two versions of the Thompson patent wrench by Diamond Wrench Co. of Portland, Maine. While photos are from ebay, examples of both wrenches are exhibited in the ACM Industrial History Center. Faceted exteriors of wrench jaws fit inside wheel hubs while jaw interiors tightly grip onto square nuts through force generated by the large winged wrenching nut.

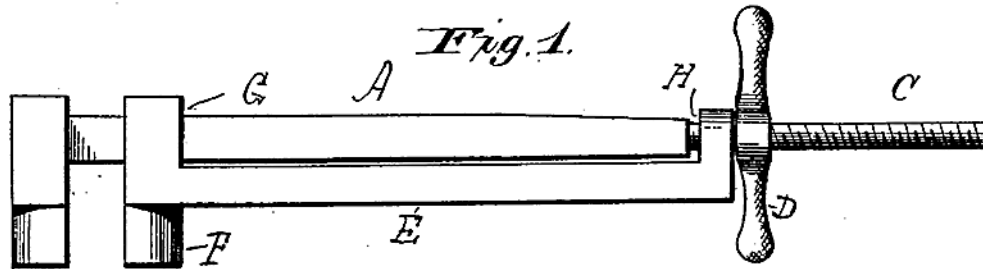

This invention relates to certain improvements in wrenches, and it is particularly designed to be employed as a nut-wrench for carriages, although it is applicable to all other purposes for which a wrench is required.

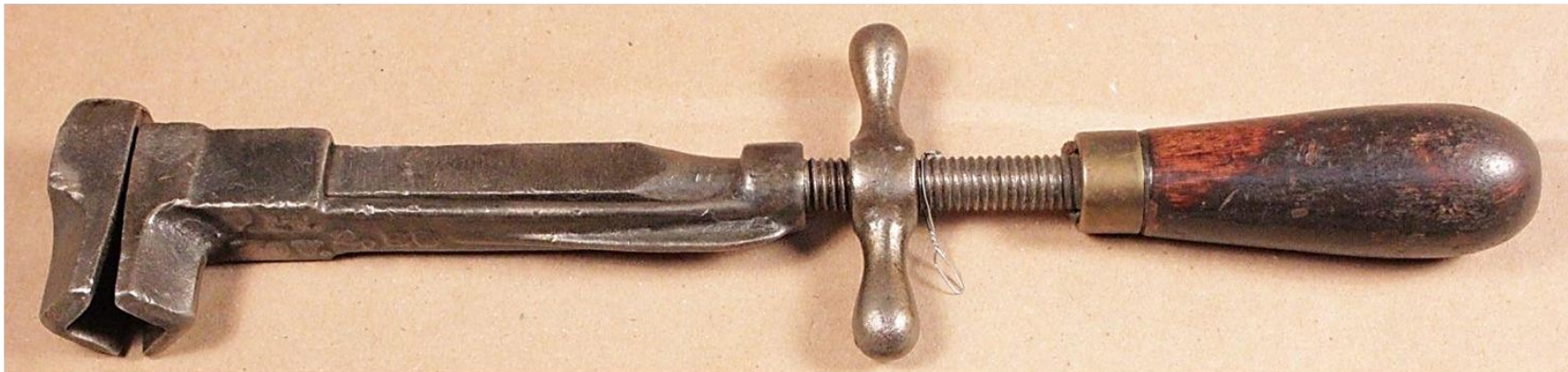

ACM Buggy Wrenches

An Unusual Adjustable Wrench

Super-Service Tool Co. of Kansas City, Missouri

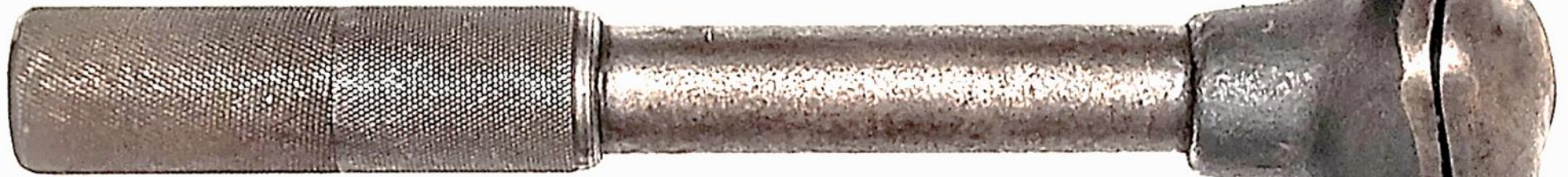

This tool has four wrenching heads, in two pairs, ganged in an assembly that opens all of them together by turning the knurled handle. Each pair has a large and a small head, one pair for square nuts and the other for hex nuts. Little has been found regarding the company or any patents. This wrench was likely for general use but had some ability to reach into wheel hubs to access axle nuts.



ACM Photos



For square nuts

For hex nuts



Samual J. Johnson Universal Wrench with Speed Handle

This ACM adjustable wrench has a rotating wood speed handle for convenient turning. Speed handles today typically entail an offset crank arm similar to the “brace” of a brace and bit, which provides high torque for boring large holes. On wrenches the crank arm can likewise produce high break-away torque for stuck nuts, and also deliver smooth convenient turning without having to re-grip the wrench at different angles to complete a full circle. This wrench originally came with a separate crank arm attachment, as seen on the next page, but as is common with such loose companion pieces, that is now missing from the ACM example.



ACM photos

Samuel Johnson Patent 530,419 - Dec. 4, 1894

The top picture is from Samuel Johnson's patent, specifically showing an axle nut removal using the crank arm attachment seen below. There was also an attachment by which the wrench could be clamped to a work bench for use as a vise. The wrenches were made by Peter Lowentraut Mfg. Co. of Newark, New Jersey, which occupied a large three-story factory having an 80 HP steam engine and 125 employees¹. They made several versions of this tool, as well general hardware and mechanics' tools.

1) <https://brace-whisperer.com/peter-lowentraut/#Leading%20Business%20Men>

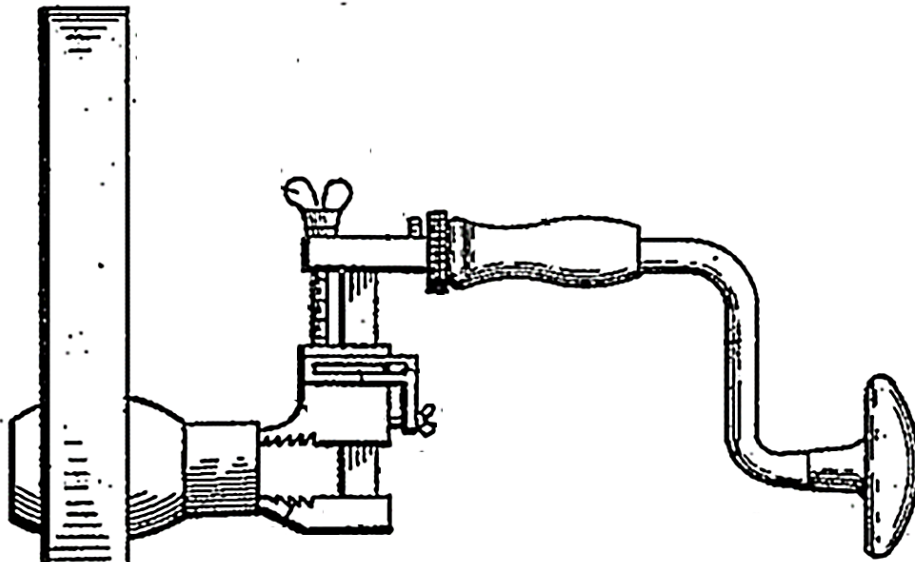

Invaluable.com

Millers Falls Adjustable Wrench with Speed Handle

Although totally unmarked this wrench is generally attributed to Millers Falls Mfg. Co. of Millers Falls, Massachusetts. The company began in 1868 in Greenfield, Mass., but relocated to Millers Falls after being destroyed by fire. The wrench is made completely of nickel-plated iron castings. It can clamp very tightly using the wing-nut adjuster. Its speed handle (red arrows) is unusually small but effective.

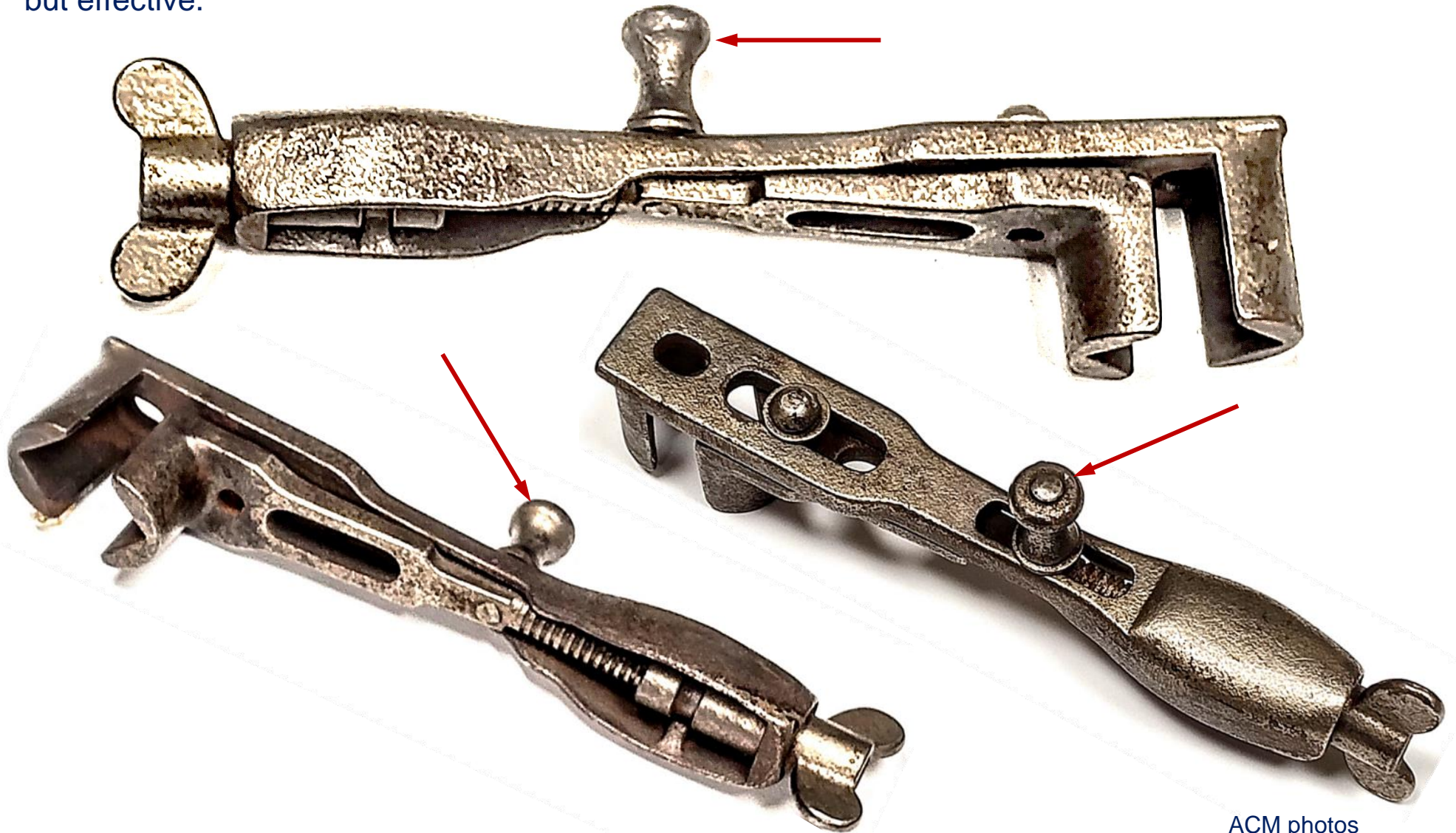

ACM photos

Unusual Adjustable Axle Nut Wrench with Speed Handle

Goodell Co. of Antrim, N. H. - Harry W. Burleigh patent 415,379 Nov. 19, 1889

The Goodell Co. of Antrim (this is not Goodell & Pratt) is generally known for manufacturing a range of apple peelers, some quite elaborate, plus other peeling and pitting devices. The wrench is spring loaded to close its jaws together. The operator pulls back the finger piece near the wood handle to disengage its ratchet and open the movable jaw until the wrench fits over an axle nut. The finger piece is then released so that the wrench grips the nut under spring load, reacted by a ratchet tooth.

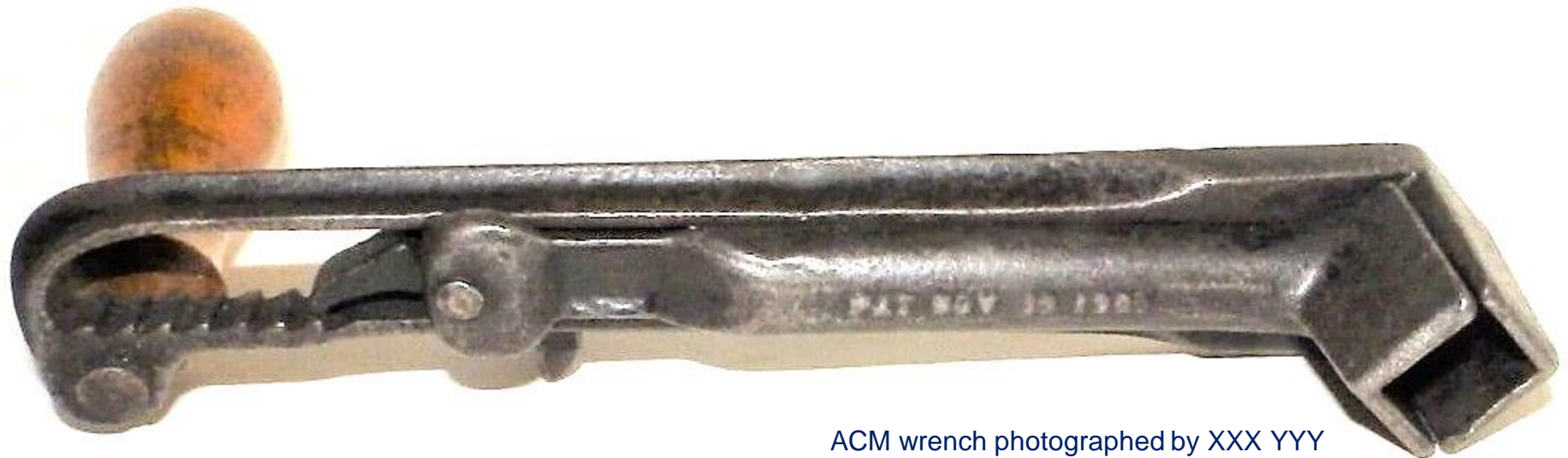
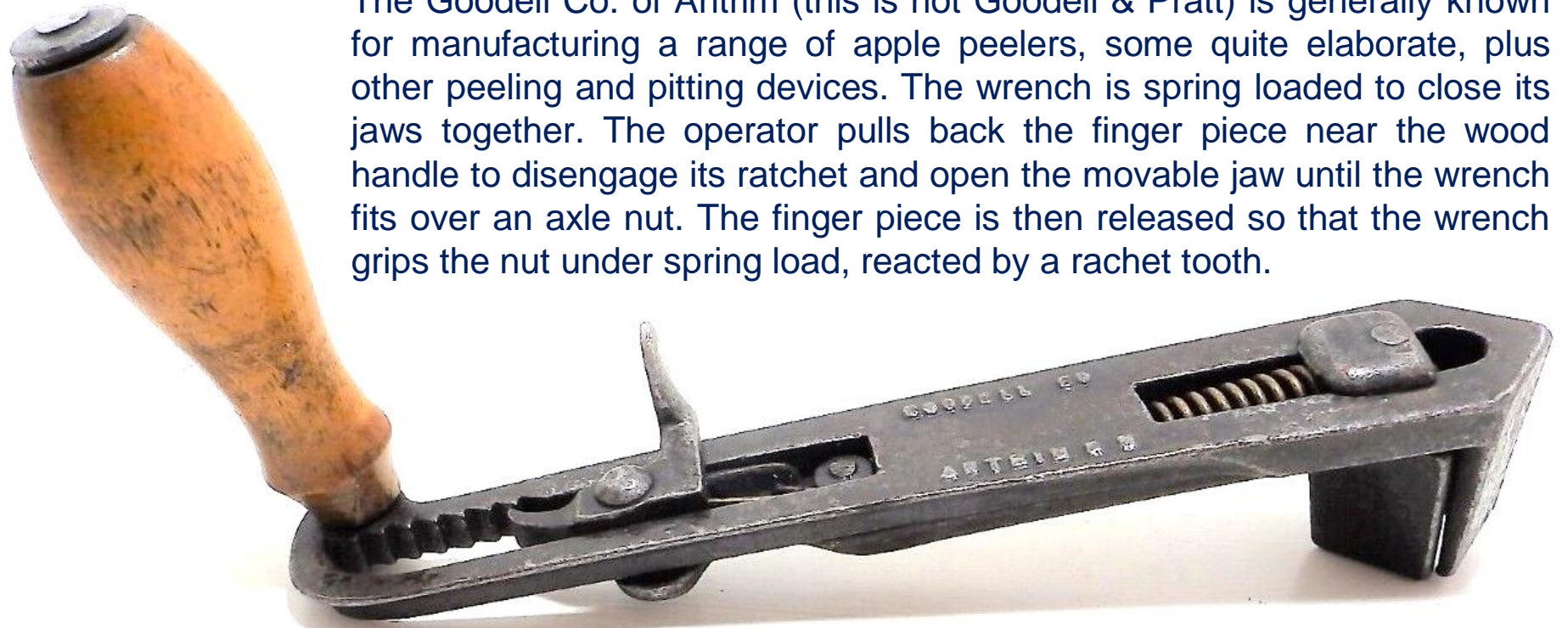

ACM wrench photographed by XXX YYY

Adin P. Joy Adjustable Wrench with Speed Handle

sideward projecting locking arm firmly secures a nut into the wrench
patent 598,319 of February 1, 1898

Rockingham Junction, N. H.,190 .

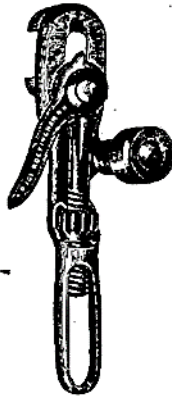

M.....

BOUGHT OF A. P. JOY,

PATENTEE AND MANUFACTURER OF

ADJUSTABLE WAGON WRENCHES.



The wrench has Adin's name on the locking lever, the patent date on the bottom of the locking lever, a squat stepped-cylinder wood handle, and a slot-head handle bolt.

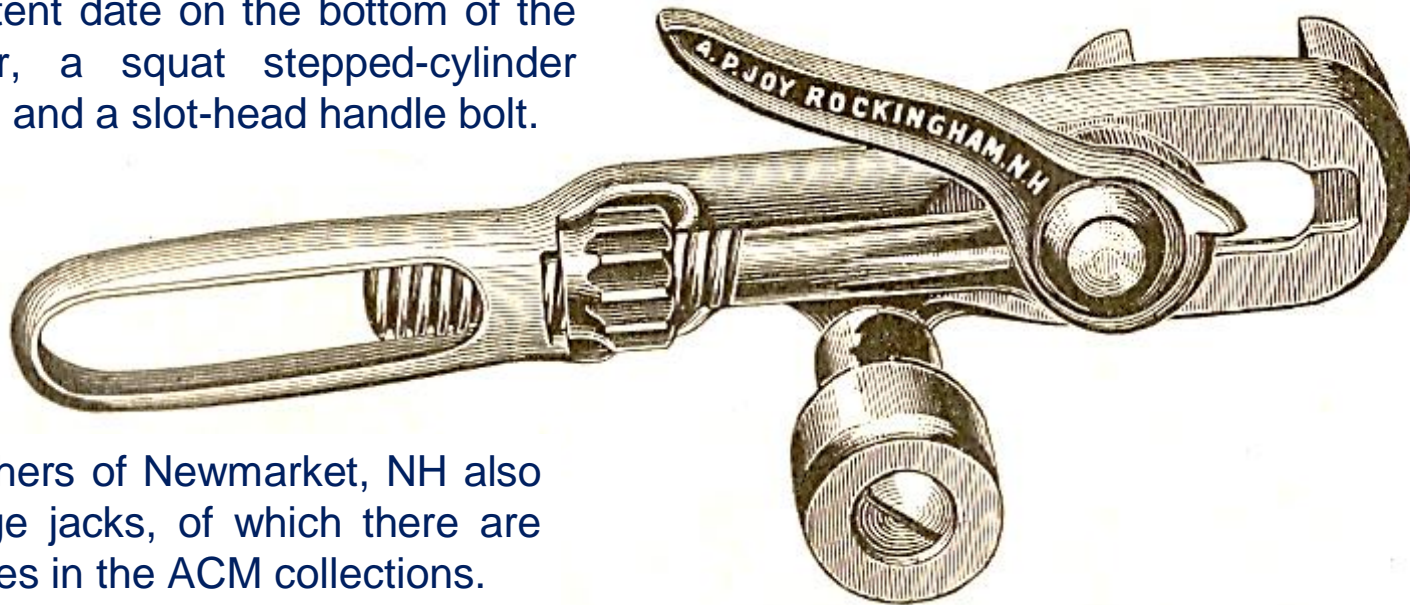

The Joy brothers of Newmarket, NH also made carriage jacks, of which there are three examples in the ACM collections.

Order slip and illustration courtesy of Newmarket Historical Society

Adin P. Joy Wrench for Gripping and Turning Axle Nuts

Adin Phillips Joy received U.S. patent 598,319 for an axle-nut wrench. The date embossed on the wrench is February 1, 1898. A. P. Joy is listed in the Newmarket directory until 1904 along with wagon jack maker S. S. Joy. Other advertising exists until 1906. At some point E. R. Klemm of Chicago began manufacturing the wrench sold as Joy's Patent Carriage Wrench. Klemm patents 806,815 and 873,868 are variations on this wrench.

Source of photo and information - <https://wrenchwiki.com/a-p-joy-patent-wagon-wrench/>

Adin specifically mentions in his patent using the wrench for lubricating axles. The wrench is made from five primary nickel-plated iron castings, a wood handle, the steel handle bolt, plus a few small pieces.

The wrench is snugged onto a square axle-nut using the ribbed thumb wheel on an adjusting screw thread, and then the nut is locked in using the locking lever that is on an eccentric. The wrench can then be readily rotated by the wood handle.

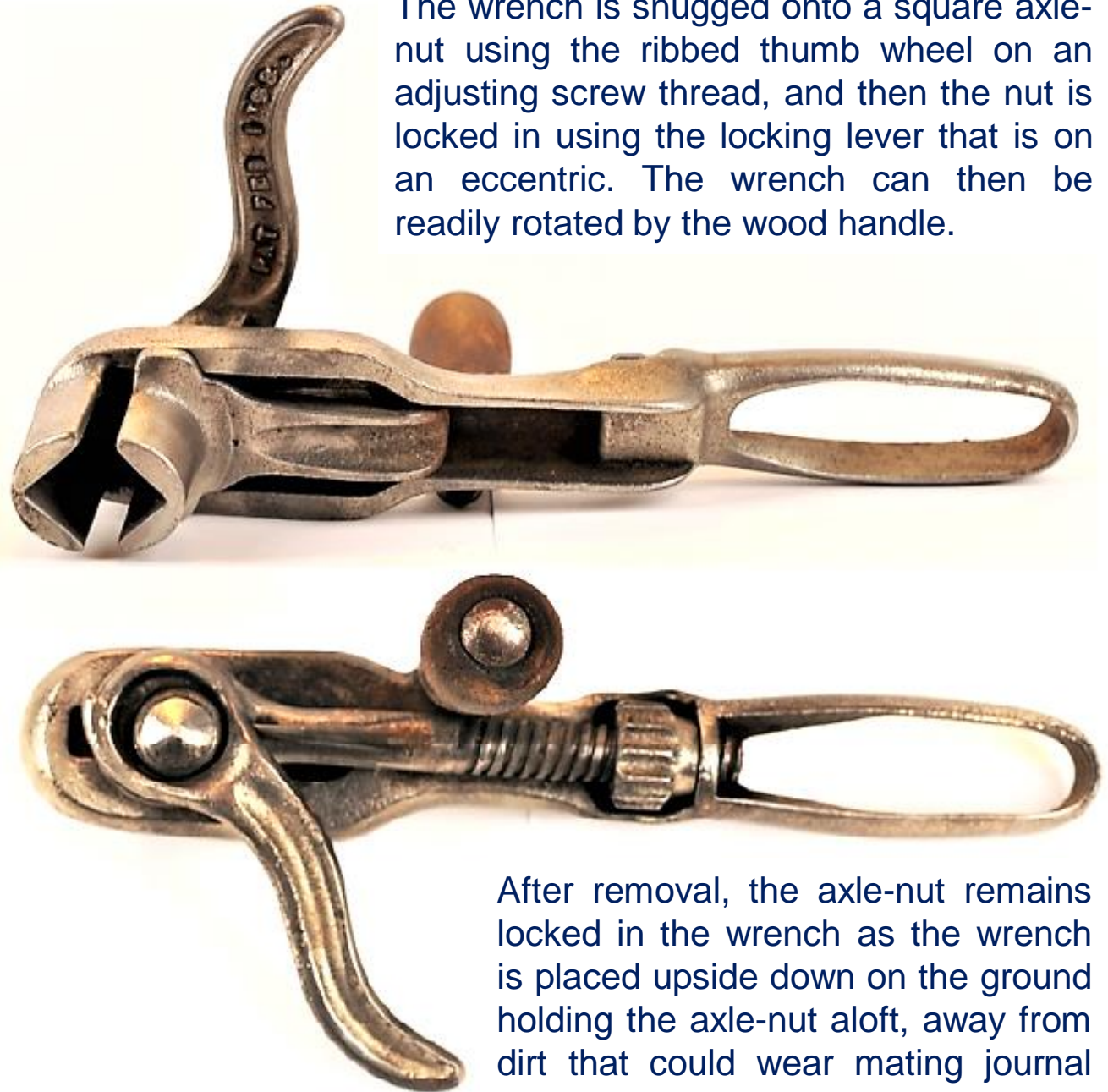

After removal, the axle-nut remains locked in the wrench as the wrench is placed upside down on the ground holding the axle-nut aloft, away from dirt that could wear mating journal components after re-assembly.

Tops of Two A. P. Joy Wrenches at ACM



The top wrench has Adin's name on the locking lever, the patent date on the bottom of the locking lever, a squat stepped-cylinder wood handle, and a slot-head handle bolt. All five primary castings, the wood handle, and its bolt are different between the two wrenches

ACM photos

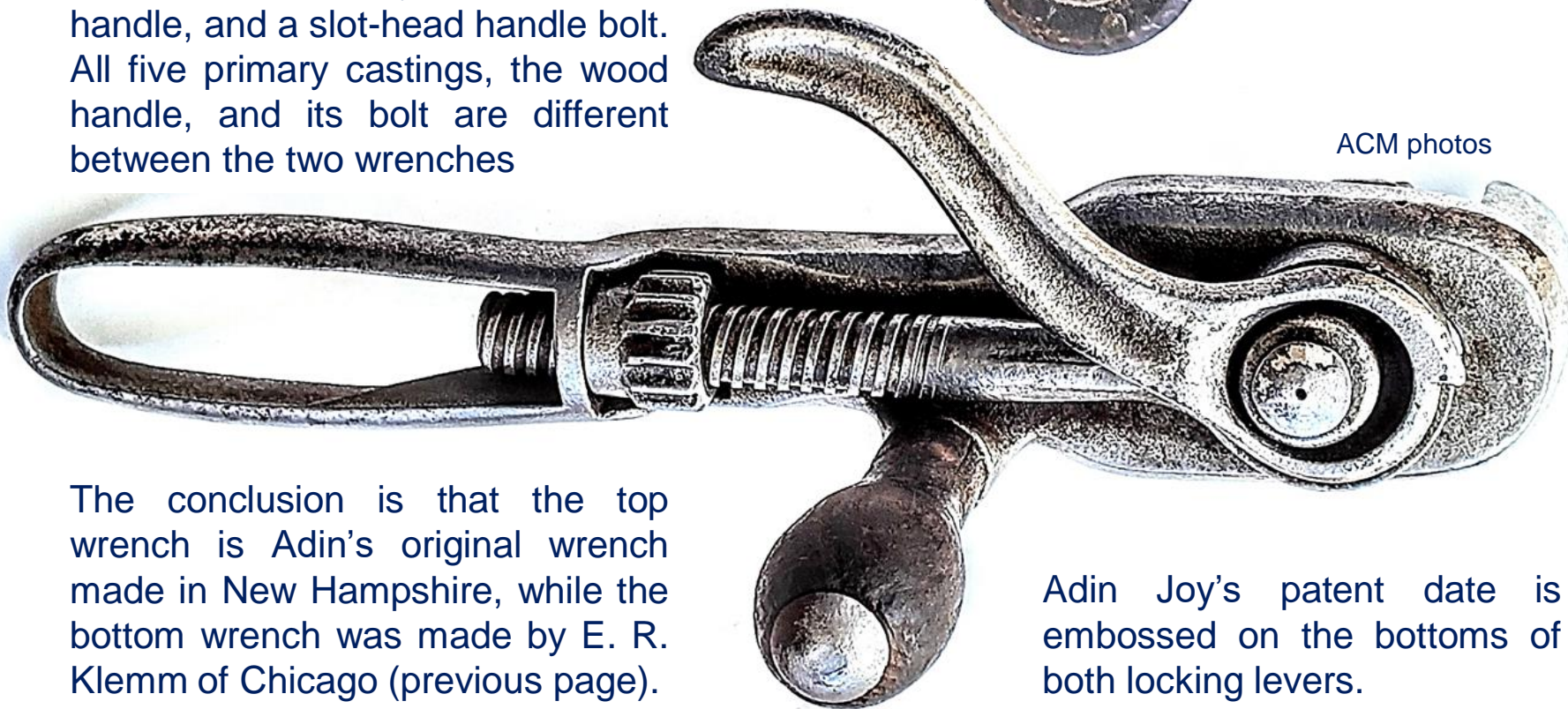

The conclusion is that the top wrench is Adin's original wrench made in New Hampshire, while the bottom wrench was made by E. R. Klemm of Chicago (previous page).

Adin Joy's patent date is embossed on the bottoms of both locking levers.

Profiles of Two A. P. Joy Wrenches at ACM

Wood handles are very different.
Slight variations in casting shapes
can be seen.



ACM photos

Then Came Wheel Bearings

1912 Catalogue of Elkhart Carriage Manufacturing Co., pgs. 8 & 10

The 1890's bicycle craze introduced into carriage making (including in Amesbury) ball bearings that reduced wheel journal friction and wear. Ball bearings eliminated sliding friction by operating with pure rolling (no sliding), and could directly react side loads without leather friction washers. Illustrations below show both the old and the new available in 1912 from a large carriage maker in Elkhart, Indiana. Note felt oil pads on the top tapered journal. Although still needing oil, ball bearings required fewer periodic wheel removals (at four wheels per carriage) for lubrication.

Our Dust Proof Bell Collar Long Distance Axle

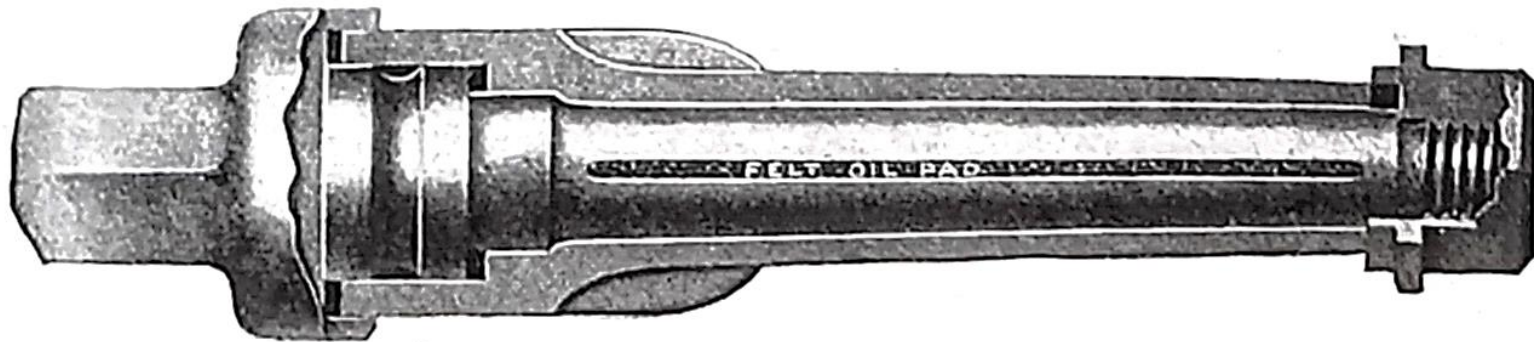

AUTOMATIC BALL BEARING AXLES

